



Navigation Aid – Digital Foghorn Detection

Because Communication is Critical

SR-8300 MK II

SOUND RECEPTION SYSTEM

Optimized Sound Reception in Challenging Marine Environments



Reliable Safety Support for Ships with Enclosed Bridges

Ensure the safety of your crew and passengers with the Zenitel SR-8300 MkII Sound Reception System. Designed to detect and reproduce foghorn and whistle sounds from other vessels, this state-of-the-art navigational aid supports safe operations in low-visibility conditions such as fog or nighttime. Compliant with international regulations, it is a key tool for safe navigation.

The SR-8300 MkII is a digital sound reception system designed to enhance navigational safety by detecting external sound signals, like foghorns, and reproducing them on the bridge. Built to withstand the toughest marine conditions, it ensures the crew can hear critical signals, improving situational awareness.

Equipped with an omnidirectional microphone, the SR-8300 Mk II captures sound signals within the 70 to 2100 Hz range from all directions, accurately reproducing them inside the bridge. Its digital signal processing and software ensures reliable detection of sound direction, even in noisy conditions.

COMPLIANCE AND CERTIFICATIONS

The SR-8300 Mk II complies with all relevant maritime regulations, including the Convention on the International Regulations for Preventing Collisions at Sea, 1972 (COLREGS) and IEC 61162-450 standards. Certified by MED MER and other Classification Societies, the system meets the rigorous requirements for maritime navigational aids, ensuring reliability in critical onboard operations.





ABOUT SR-8300 MK II SOUND RECEPTION SYSTEM

FEATURES

- Reliable performance in **extremely demanding conditions**.
- Seamless integration with existing vessel infrastructure.
- Compact design with only two main components.
- **Quick and easy installation** on vessels of any size, featuring **self-calibrating** capabilities.
- Full compliance with maritime performance standards and regulations, including COLREGs and IEC standards.

WEB-BASED USER INTERFACE

The SR-8300 MK II system includes a web-based configuration tool that ensures:

- User-friendly, quick, and efficient setup.
- Real-time system monitoring & diagnostics.
- Easy access via a standard web browser.
- Flexible settings for optimal performance.

System Overview

Scan or click [HERE](#) for a full overview of our SR-8300 MK II Sound Reception System



Sound Reception P-8300 MK II

System Configuration / Block Diagram - Master/Slave

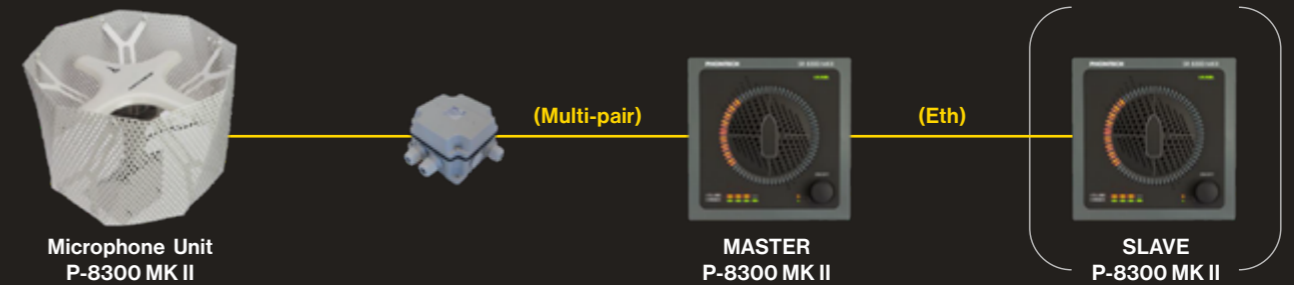

Sound Reception P-8300 MK II



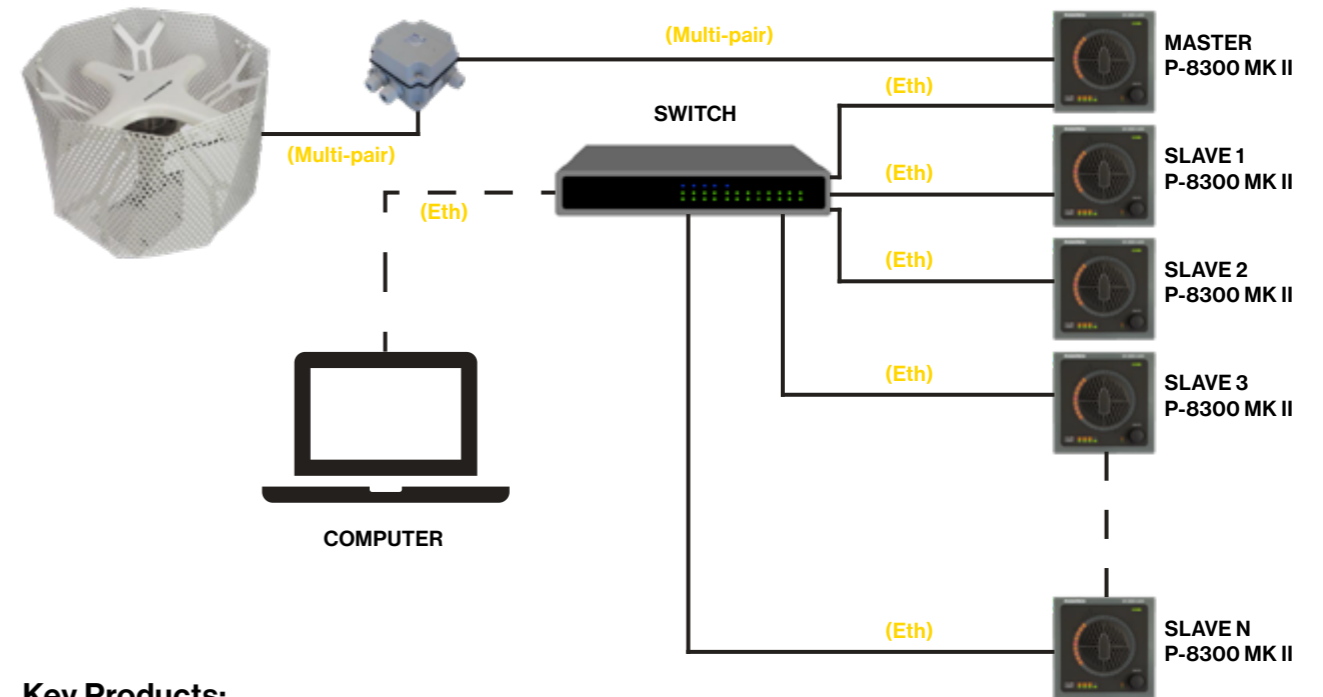







System Configuration / Block Diagram / Master / Multiple Slaves / Configuration Computer



Key Products:

Order Number	Description
4000019415	P-8300 MK II Sound Reception Display Unit: Flush-mounted display unit with LED indicators and built-in loudspeaker.
4000019634	Junction Box for P-8301 Microphone: Connects microphone and display unit for reliable signal transmission.
4000019416	P-8301 MK II Microphone Unit: Durable outdoor microphone cluster designed to capture sound signals across 360 degrees.
2220010120	RJ45 Port locker kit, black for maintaining Cyber Security.



 <p>System "Remote Control" via VPN</p>	 <p>Training</p>	 <p>24/7 Service</p>	 <p>Service agreements</p>	 <p>Type-approved systems</p>
 <p>Innovative technology</p>	 <p>Monitoring of system solution with follow-up on sailing ships</p>	 <p>Spare parts policy</p>	 <p>Extended warranty terms</p>	 <p>Crew training program</p>

WHY ZENITEL?

You need systems that work. Every time. We provide reliable and resilient integrated communication solutions. We understand that the safety and efficiency of your most valuable resource – your employees – is key to your success.

We're specialists in the maritime and energy segments: we know the ocean industry, and we speak your language. Our innovative solutions for critical and intelligent communication deliver reliable performance in all conditions. We also understand your need to safeguard your assets, whether it is an ocean-going vessel or an energy plant. That's why we offer integrated communication solutions that enable seamless information sharing, so you can make better decisions more quickly.

Our systems and solutions provide high availability, scalability, reliability, maintainability and cyber defensibility. Our flexible and innovative solutions for intelligent communication, data, safety and entertainment systems deliver reliable performance in all conditions.