

**COBHAM**

# SAILOR SP3520 Portable VHF GMDSS

User manual



## Emergency procedure

- Turn the knob at the top of the radio clockwise. The display lights up showing the last used channel and the battery level.
- Select channel 16 (Distress or Safety), press the **16/C key**.
- Press the PTT and say:
  - "MAYDAY, MAYDAY, MAYDAY",
  - "This is" ..... ships name repeated three times
  - 
  - "MAYDAY"
  - "This is" ..... ships name and call sign,
  - The ship's position in latitude and longitude or other reference to a known geographical location,
  - The nature of distress and assistance wanted,
  - Any other information which might facilitate the rescue.
  - "OVER"
- Release PTT and listen for answer.

# SP3520 VHF GMDSS

**Document number:** 98-124294-K

**Release date:** November, 2016

**Copyright:** © 2016 Thrane & Thrane A/S. All rights reserved.

## Trademark Acknowledgements

- **SAILOR** is a registered trademark of Thrane & Thrane A/S.
- **Other product and company names** mentioned in this manual may be trademarks or trade names of their respective owners.

## Warranty limitation

IMPORTANT - The radio is a sealed waterproof unit. To create and maintain its waterproof integrity it was assembled in a controlled environment using special equipment. The radio is not a user maintainable unit, and under no circumstances should the unit be opened except by authorized personnel. Unauthorized opening of the unit will invalidate the warranty.

## Disclaimer

Any responsibility or liability for loss or damage in connection with the use of this product and the accompanying documentation is disclaimed by Thrane & Thrane A/S. The information in this manual is provided for information purposes only, is subject to change without notice and may contain errors or inaccuracies. Manuals issued by Thrane & Thrane A/S are periodically revised and updated. Anyone relying on this information should acquire the most current version e.g. from [www.cobham.com/satcom](http://www.cobham.com/satcom), **Service and support**, or from the distributor. Thrane & Thrane A/S is not responsible for the content or accuracy of any translations or reproductions, in whole or in part, of this manual from any other source. In the event of any discrepancies, the English version shall be the governing text.

Thrane & Thrane A/S is trading as Cobham SATCOM.

## Precautions

Avoid water and salt in the I/O connector and keep it clean frequently.

Only use original Thrane & Thrane battery packs. Make sure they are clean and dry before attaching the transceiver. Be careful not to damage any gaskets.

Only use the original Thrane & Thrane charger for the rechargeable battery.

Be very careful when handling the Lithium batteries. With correct use they are safe but any misuse might cause dangerous situations.

Never short circuit the battery terminals, never expose the transceiver and the batteries to extreme temperature or fire and never use any kind of violence.

Avoid close contact between the antenna and parts of the human body. The top of the antenna must never be closer than 5 cm to the body when transmitting.

Do not submerge the transceiver more than 1 m for 30 minutes.

Keep the transceiver at least 0.3 m away from the magnetic compass.

## Training information

SAILOR SP3520 VHF GMDSS is designed for "occupational use only". It must be operated by licensed personnel only.

The SP3520 complies with the FCC RF exposure limits for "Occupational Use Only".

- FCC OET Bulletin 65 Supplement C, evaluating compliance with FCC guidelines for human exposure to radio frequency electromagnetic fields.
- American National Standards Institute (C95.1) IEEE standard for safety levels with respect to human exposure to radio frequency electromagnetic fields, 3 kHz to 300 GHz.
- American National Standards Institute (C95.3) IEEE recommended practice for the measurement of potentially hazardous electromagnetic fields - RF and microwaves.



**Warning!** Your Thrane & Thrane VHF radio generates electromagnetic RF (radio frequency) energy when transmitting. To ensure that you are not exposed to excessive amounts of energy and thus to avoid health hazards from excessive exposure to RF energy, all persons must be at least 5 cm away from the antenna when the radio is transmitting.

## Correct use

For best performance, hold the radio vertically and 10 cm away from the head when talking into the microphone.



# Contents

---

## Chapter 1 Introduction

<b>Your VHF GMDSS</b> .....	1
<b>Performance</b> .....	2
<b>Channels</b> .....	2

## Chapter 2 Operation

<b>Controls</b> .....	3
Keys and buttons .....	3
The display .....	5
<b>Using the VHF GMDSS</b> .....	6
Basic functions .....	6
Other functions .....	9
<b>Configuring the VHF GMDSS</b> .....	11
Entering and using configuration mode .....	11
Configuration settings .....	12

## Chapter 3 Batteries

<b>Battery types</b> .....	15
<b>The primary battery</b> .....	15
<b>The secondary battery</b> .....	16
Battery level indication .....	16
Removing and inserting the battery pack .....	16
The battery charger .....	17
Installing the charger .....	17
Recharging the secondary battery .....	18

---

## Chapter 4 Equipment and accessories

<b>External equipment</b> .....	19
List of equipment .....	19
Connecting external equipment .....	19
Impact on radio operation .....	20
Accessory connector .....	20
<b>Accessories</b> .....	21
List of accessories .....	21
Attaching and removing the belt clip .....	23
Attaching the lanyard .....	23

## Chapter 5 Troubleshooting

Displaying errors .....	25
-------------------------	----

## App. A Technical specifications

<b>Technical data VHF GMDSS</b> .....	27
General .....	27
Transmitter .....	28
Receiver .....	28
<b>Battery life guidelines</b> .....	29
Primary battery (non-rechargeable) .....	29
Secondary battery (rechargeable) .....	29
<b>Dimensional drawing, transceiver</b> .....	30
<b>Dimensional drawing, chargers</b> .....	31

## App. B Attention

<b>Gore-Tex Membrane</b> .....	33
--------------------------------	----



## Introduction

### Your VHF GMDSS

SP3520, your new portable VHF transceiver, is approved to fulfil the GMDSS requirements for portable VHF radios for Safety at Sea and is waterproof to the IP67 standard.

As part of the required safety equipment, the SP3520 is to be used in an emergency situation. However the best way to guarantee functionality in an emergency situation, is to use the radio in daily communication on board.

The SP3520 is designed for daily use and it connects easily to external equipment like headsets and fist mikes, making the SP3520 suitable for any noisy environment.

The unique battery concept makes the radio suited for both daily use and emergency situations. The primary emergency battery is to be stored for emergency situations and a secondary rechargeable battery can be used for daily communication in your new portable VHF transceiver.

The radio is designed with a unique man machine interface, an excellent grip even with gloves, and large tactile buttons.

The display has red adjustable backlight which makes the display visible even at night.



The radio is equipped with a lanyard and a belt clip. A huge accessory program comes with the SAILOR SP3500 series.

Please find the nearest SAILOR distributor on [www.cobham.com](http://www.cobham.com)

## Performance

For best performance of the transceiver keep the following in mind:

- Keep clear of metal environment.
- Hold the transceiver vertically and 10 cm from lips and push the PTT when transmitting.
- In receive mode carry the transceiver vertically with belt clips.
- To preserve battery power, adjust squelch to close the loudspeaker when there is no signal.

If you are in a lifeboat keep the antenna as high as possible.

## Channels

This radio operates with the following channels according to the Radio Regulations Appendix 18.

**Note**

Channel designators xxA corresponds to 10xx defined in the Radio Regulations Appendix 18.

6	12	17	67	73	78A
8	13	19A	68	74	79A
9	14	20A	69	75 <b>LJ</b>	87
10	15	27A	71	76 <b>LJ</b>	88
11	16	28A	72	77	

**LJ** Tx power is limited to 1 W.

## Operation

### Controls





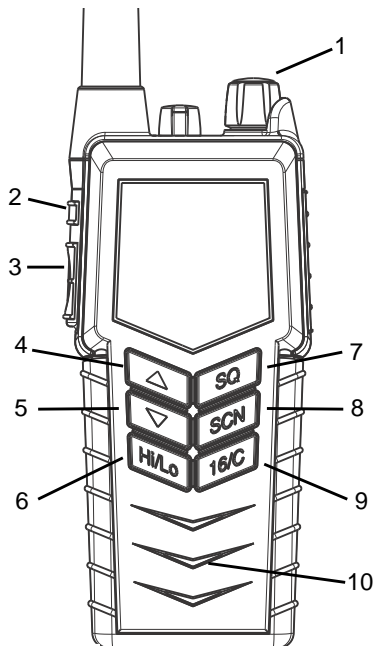

#### Keys and buttons

1. On/off/volume
2. Light/Lock
3. Push To Talk (PTT)
4. Up key
5. Down key
6. Hi/Lo output power
7. Squelch
8. Scan
9. Priority channel (16)/  
Call channel
10. Loudspeaker/microphone



## Key presses

Pressing and holding certain keys gives access to additional functions, shown in the table below.

Key	Short press (1 beep)	Long press (2 beeps)	Extra long press (3 beeps)
 	<p>Show next available item in the list (up or down).</p> <p>Default: Channel selection</p>	<p>Run through available items, <b>or</b> select tagged channels A (▼) or B (▲).</p>	<p>Run through available items if an A or B channel is tagged</p>
	<p>Activate Squelch control (Adjust with up/down arrows).</p>	<p>Monitor function. Open Squelch completely.</p>	
	<p>1 press: Activate/terminate Dual/Triple watch.</p> <p>2 presses: Activate memory scan.</p>	<p>Add/Delete channel from memory scan.</p>	
	<p>Toggle between high and low transmitter power.</p>		
	<p>Select channel 16.</p>	<p>Select programmed Call channel.</p>	<p>Program Call channel.</p>

## The display

The display holds various fields of information, explained below.

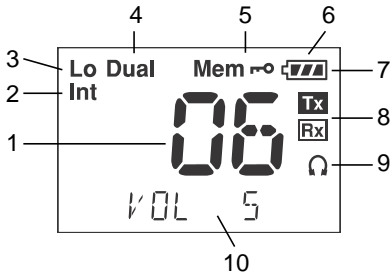

1. Current working channel.
2. Current channel mode.
3. “Lo”: Reduced transmitter power.  
Full transmitter power is not shown in display.
4. Dual watch activated.
5. Current working channel is marked for scanning.
6. Keypad is locked.
7. Battery level indicator.
8. Transmitting (Tx) /Receiving (Rx).
9. Accessory is connected.
10. Service line for various purposes. In this example the volume level.

## Using the VHF GMDSS

### Basic functions

**Note** Before using the radio, mount the antenna at the top of the radio. The antenna is delivered with the radio.

#### *Switching the radio on and off*

- **To switch the radio on**, turn the knob at the top of the radio **clockwise**.  
The display lights up showing the last used channel and the battery level.
- **To switch the radio off**, Turn the knob back **counter-clockwise** until it clicks.



#### *Selecting the working channel*

- To select **channel 16** (Distress or Safety), press the **16/C** key.
- To select the **Call channel**, use a long press on **16/C**.
- To select among **all available channels**, press **▲** or **▼** on the keypad.  
For fast selection, press and hold **▲** or **▼**.

The display shows the currently selected channel.

**Note** Long press on **▲** or **▼** can also be used to select preferred channels. For information on how to program preferred channels, see *Configuring the VHF GMDSS* on page 11  
*Configuring the VHF GMDSS* on page 11.

### **Activating a call**

To **activate a call** to the selected channel, press and hold the **PTT** button on the side of the radio.

The radio transmits as long as the PTT button is pressed. A small **Tx** sign next to the channel number indicates when the radio is in transmit mode.

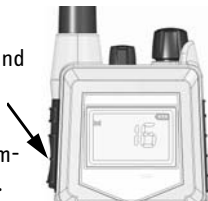

### **Adjusting the volume**

- To **increase** the volume, turn the on/off knob at the top of the radio **clockwise**.
- To **decrease** the volume, turn the knob **counter-clockwise**.

The display shows the level of the volume, e.g. “VOL 5”, while it is adjusted.

### **Using Squelch control**

- To **activate** Squelch control, press the **SQ** key.
- To **set** the Squelch level, press ▲ (closing) or ▼ (opening). The display shows the Squelch level while it is adjusted, e.g. “SQ 5”.

### **Adjusting the display backlight**

- To **turn on** the backlight, press the **Light/Lock** button on the side of the radio.
- To **adjust** the backlight level, press ▲ or ▼ within 3 seconds after turning on the light. The display shows the level while it is adjusted, e.g. “DIM MED”.



### ***Using Dual watch***

**To activate** Dual watch, press the **SCN** key.

The display shows “Dual” at the top and “16” at the bottom right.

The radio toggles between the selected channel and channel 16.

- **To terminate** Dual watch, press **SCN** again.

### ***Scanning channels***

- **To activate** scanning memory, press 2 times **SCN** within 2 seconds.

During scanning, the display shows “SC” in the channel field. The radio toggles between channel 16 and each of the channels marked for scanning.

- **To terminate** scanning, press **SCN** once.

### ***Changing the transmitter power***

**To change** the transmitter power, press the **Hi/Lo** key. The display shows “LO” when power is set to low. Otherwise maximum power is used.

### ***Locking the keypad***

- **To lock** the keypad, press and hold the **Light/Lock** button. The display shows a key symbol when the keypad is locked.
- **To unlock** the keypad, press and hold the **Light/Lock** button again.



---

## Other functions

### *Programming the Call channel*

To program the Call channel, do as follows:

1. Press and hold **16/C** until the current Call channel number is flashing.
2. Select the channel with **▲** or **▼**.
3. Press **16/C** to confirm.

### *Programming the scanning memory*

**To add** a channel to the scanning memory, select the channel and then press and hold the **SCN** key until the display shows **MEM** at the top.

**To remove** a channel from the scanning memory, select the channel and then press and hold the **SCN** key until the **MEM** sign disappears from the display.

### *Alive beep*

**To enable** “ALIVE” function do as follows:

1. Select the channel where ALIVE function is desired to be transmitted.
2. Press and hold the **Hi/Lo** until you see “ALIVE ON” on the radio display. It takes approx. a second.
3. Now “ALIVE” is transmitted by a “beep” on the working channel, with approx. 4-second intervals.

**To deactivate** “ALIVE” function do as follows:

- Press and hold the **Hi/Lo** pressed until “ALIVE ON” no longer appears on the radio display. It takes approx. a second.

“ALIVE” function is also deactivated when

- The channel is changed.
- The radio is turned OFF and ON again.
- Watch or scanning is enabled.
- Squelch is open.

Refer to *ALIVE* on page 13

---

## Configuring the VHF GMDSS

### Entering and using configuration mode

**Note** | The radio is not operational in configuration mode.

- **To enter** configuration mode, press and hold the **Light/Lock** button while turning on the radio.  
The bottom line of the display shows the current menu item/setting.
- **To exit** configuration mode, turn off the radio or press any key except **▲**, **▼** and the Light/Lock button.  
Using the PTT button or leaving the radio inactive for 10 seconds also causes the radio to exit configuration mode.
- **To change** a setting, press **▲** or **▼**.
- **To confirm the current setting** and go to the next menu item, press the **Light/Lock** button.

## Configuration settings

Configuration mode is used to program preferred channels and volume of key beep and battery alarm.

The following settings are available in configuration mode.

BEEP	MAX	Status click/beep sound on key press, long press (settings/programming saved) and battery alarm. Maximum level.
	MIN	Status click/beep sound on key press, long press (settings/programming saved) and battery alarm. Minimum level.
	OFF	All beeps off.
PREFA	OFF	Remove tag "A" for current working channel.
	ON	Tag current working channel with "A". If another channel was previously tagged "A", this is overruled. <ul style="list-style-type: none"> <li>The working channel can now be selected with a long press on ▼.</li> </ul>
PREFB	OFF	Remove tag "B" for current working channel.
	ON	Tag current working channel with "B". If another channel was previously tagged "B", this is overruled. <ul style="list-style-type: none"> <li>The working channel can now be selected with a long press on ▲.</li> </ul>
VER	X.XX.XX	Software version. Read-only.

ALIVE	OFF	Factory default state.
	ON	Press ▲ to set “ALIVE” on.
ADD NAME	A-Z, 0-9	Makes it possible to name the channels. The name must contain a maximum of 9 characters, use only capital letters, digits and spaces. Press <b>Light/Lock</b> to confirm programming. Note: The name appears in the service line on the display.



## Batteries

### Battery types

- The yellow primary battery pack contains a non-rechargeable Lithium battery. This battery pack is only to be used in case of emergency.
- The black secondary battery pack contains a rechargeable battery. This battery pack is for daily use.

### The primary battery

#### Important

The yellow primary battery pack is only for emergency use, and is **not** rechargeable.

Before using the primary battery, remove the seal on the battery pack.

Then do as follows:

1. Attach the battery pack to the radio as shown.
2. Lock the battery with the safety lock at the bottom.

The primary battery is capable of providing sufficient power for 8 hours of operation defined as 10% Tx, 10% Rx and 80% standby.

When the primary pack is not in use it must always be placed in the dedicated rear position in the charger cradle, see *The battery charger* on page 17.

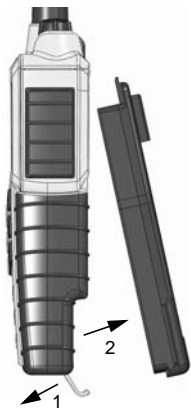

## The secondary battery

### Battery level indication

The black secondary battery pack is for daily use of the radio. When the battery level is low, you should recharge the battery.

The radio display shows the battery status. When the battery symbol is empty and flashing, the battery should be recharged as soon as possible.

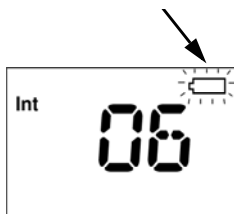

### Removing and inserting the battery pack

**To remove** the battery pack, do as follows:

1. Open the safety lock as shown.
2. Remove the battery.

**To insert** the battery pack, attach the battery and close the safety lock as shown on the previous page.

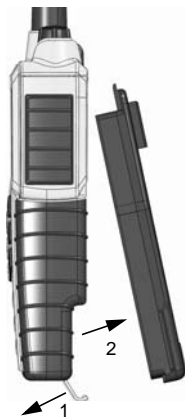



## The battery charger

The charger has two compartments.

### **Single Charger Kit**

- A rear compartment only for storing a spare battery. It does not have a charger function.
- A front compartment for recharging the battery alone or while attached to the radio.

### **Dual Charger Kit**

- It is possible to charge a battery in rear compartment simultaneously with the radio/battery in front.

## Installing the charger

### **Mounting the charger**

There are several options for mounting one or more chargers on a table or a wall.

For information on dimensions and screw positions, refer to *Dimensional drawing, chargers* on page 31.

When mounting the charger, make sure it is placed in a dry place and away from direct sunlight. The charger is not waterproof.

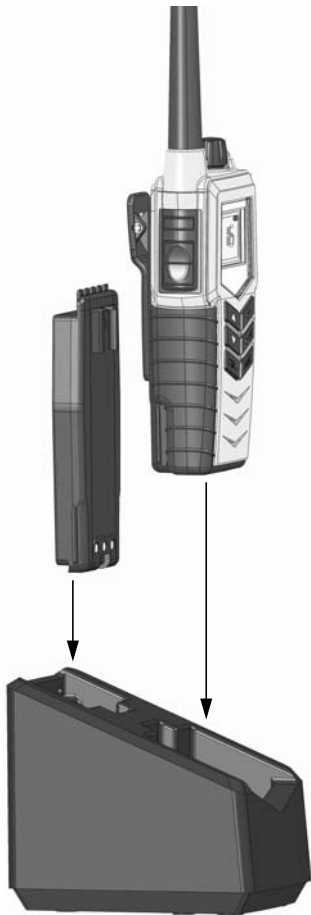

## Connecting to power

The charger can be supplied with DC or AC.

**DC:** Connect the 12-24VDC Connection Cable between the DC supply and the connector on the underside of the charger.

**AC:** Connect the AC/DC adapter to the connector on the underside of the charger. Then connect the AC/DC adapter to the AC outlet.

## Recharging the secondary battery

**Important** | Do not attempt to recharge the yellow primary battery!

To recharge the secondary battery, place the radio with battery or the battery alone in the front position of the charger cradle.

If the radio cannot turn on due to completely discharged battery, then **turn off** the radio and place it in the charger or charge the battery alone.

The light indicators on the charger cradle show the status as follows:

- Green light: Power is connected to the charger.
- Slow red flash: Charging in progress.
- Quick red flash (twice per second): Charging error, e.g. battery defect or temperature out of range.
- Steady red light: Charging completed. Trickle charge mode.

Charging time with empty battery: VHF off approx. 4 hours, VHF on: approx. 5 hours.

The battery indicator on the radio display indicates if the radio is placed in the charger while radio and charger are both powered.



## Equipment and accessories

### External equipment

#### List of equipment

The following equipment can be connected to the radio:

- SAVOX 400E Push-To-Talk unit
- SAVOX C500 Fist Mike
- SAVOX NC/400 Noise-com
- SAVOX HC-E Helmet-com
- SAVOX K53004 Helmet unit
- Peltor MT7H79 Headset

We recommend to remove all accessories during emergency use.

All accessories listed might be used when body worn.

#### Connecting external equipment

Connect the dedicated interface cable between the external equipment and the top connector on the radio.

Interface cable	Order number
For SAVOX 400E	403500-940
For SAVOX C500	403500-950
For Peltor FL5061	403500-951



When external equipment is connected to the radio, the right side of the display will show a headset.

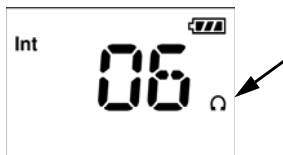

## Impact on radio operation

The external equipment can have a built-in PTT button, speaker and microphone. Thus a connection has per default the following impact on the radio operation:

- If a speaker or earpiece is built into the detected external equipment, the sound device of the external equipment is used, and the internal radio speaker is disabled.
- The external accessory microphone is selected as audio input device, when the external PTT button is pressed. The transceiver microphone is used as audio input device when the transceiver PTT button is pressed.
- This behaviour can be changed in the service tool.

## Accessorie connector

- Pin 1. Loudspeaker,  
minimum 8 ohm impedance.
- Pin 2. Accessory power,  
5V maximum 0.03A.
- Pin 3. Microphone input,  
 $R_i = 2.2\text{kohm}$ , 3V phantom power.
- Pin 4. GND

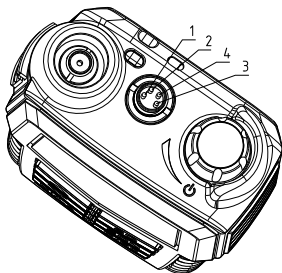

## Accessories

### List of accessories

The following accessories are delivered with your radio:

Accessory	Part number
Primary battery (yellow, non-rechargeable), B3501	403501A
Secondary battery (black, rechargeable), B3502	403502A
Charger, CH3507	403507A
AC/DC converter, length 150cm (100-240V~ /12VDC out)	88-125538
12-24VDC Connection cable, length 150cm	37-124381
Belt clip	62-124320
Antenna	88-124370
Lanyard	41-124375
User Manual (this manual)	98-124294

**Batteries, charger, AC/DC Converter** and **12VDC Connection** are described in *Batteries* on page 15.

To mount the **antenna**, simply screw it into the threaded bush at the top of the radio.

Use of **lanyard** is only for hand held operation. Put it around the wrist to prevent dropping the radio.

### Accessories you may buy

Accessory	Part number
Dual Position ChargerCH3508	403508A
Leather Case	403500-205

### Leather Case



### Warning!

The display must always be kept away from the body to reduce the RF exposure when body worn.

## Attaching and removing the belt clip

**To attach** the belt clip, slide the belt clip upwards into the rails at the back of the radio until it locks.

**To remove** the belt clip, press the projection at the top of the belt clip to release the lock and slide the belt clip downwards out of the rails.

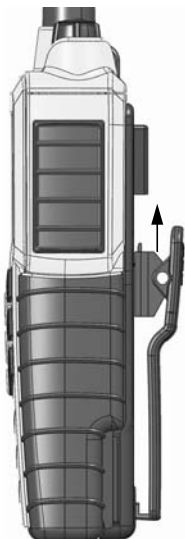
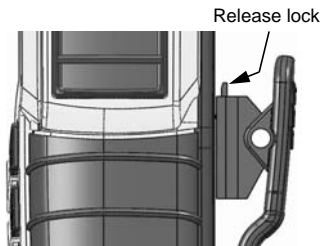

## Attaching the lanyard

Do as follows:

1. Take the lanyard through the eye at the top of the radio.
2. Put one end of the lanyard through the loop at the other end of the lanyard and pull to tighten.

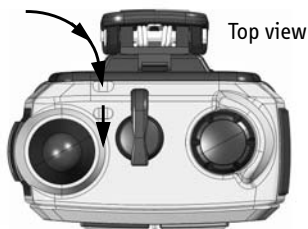





## Troubleshooting

### Displaying errors

Some errors result in an error message in the display. These error messages are listed below.

Display text	Problem	Type	Actions
Err EMPTY BAT	The battery voltage is below a critical level, where further operation would damage the battery.	Severe. Radio is non-functional.	Change/recharge the battery.
Err HW ERR	Hardware error.	Severe. Radio is non-functional.	Service required.
ILLEGAL	Context fails operation. This text will appear on the following occasions: <ul style="list-style-type: none"> <li>• Multiple watch is selected on channel 16, or in channel regions where it is not allowed.</li> <li>• High power is selected on a channel where it is prohibited.</li> <li>• Transmission on blocked channels</li> </ul>	Fail operation	Consider operation in a different context.



## Technical specifications

### Technical data VHF GMDSS

#### General

Item	Specification
RX frequency range	155.000 - 163.425 MHz
TX frequency range	155.000 - 161.450 MHz
Modulation	16K0G3E
Power supply	7.2 VDC Li battery
Current drain at 2 W TX	1.4 A
Current drain at 1 W TX	0.8 A
Current drain RX max audio	0.25 A
Antenna port	50 ohm
Primary Battery	Lithium Iron Disulfide, 3000 mAh
Secondary Battery	Lithium-Ion, 1800 mAh rechargeable
Operating temperature	-20°C to +55° C
Water ingress protection	IP67
Frequency stability	Better than $\pm 0.7$ kHz
Weight with emergency battery	340g

## Transmitter

Item	Specification
RF output power	2 W /1 W
RF output power, Canada	2.5 W $\pm$ 1 dB / 0.75 W $\pm$ 1 dB
Max deviation	$\pm$ 5 kHz
Spurious emission	< 0.25 $\mu$ W
Adjacent channel power	> 70 dB

## Receiver

Item	Specification
Sensitivity (20 dB SINAD)	-117 dBm typical
Intermodulation	Better than 70 dB
Spurious response	> 70 dB
Adjacent channel selectivity	> 70 dB
Audio output, internal	0.25 W at 10% dist.
Audio output, external	0.25 W/8 ohm

## Battery life guidelines

### Primary battery (non-rechargeable)

The primary non-rechargeable battery pack is capable of providing sufficient power for the specified 8 hours according to regulations.

The battery is marked with an expiry date. Replace the battery at or before this date.

To ensure a long lifetime keep the battery in the store position in the charger and avoid high temperature and direct sunlight.

### Secondary battery (rechargeable)

**Note**

New batteries should be placed in the charger for minimum 12 hours first time.

During daily use, always keep the battery fully charged and away from hot areas.

Keep the battery terminals dry and clean.

Never discharge beyond the specifications of the battery.

Operation/Standby time depends on usage. Generally, the more the radio is transmitting, the faster it will drain the battery. Also, the “Hi” power setting will drain the battery faster than the “Lo” setting.

**Approximate** figures are:

- A battery can be stored for 4 to 6 month at 25°C if charged to 25%.
- The battery will normally last for 5 to 9 hours of use on a fully charged battery.

## Dimensional drawing, transceiver

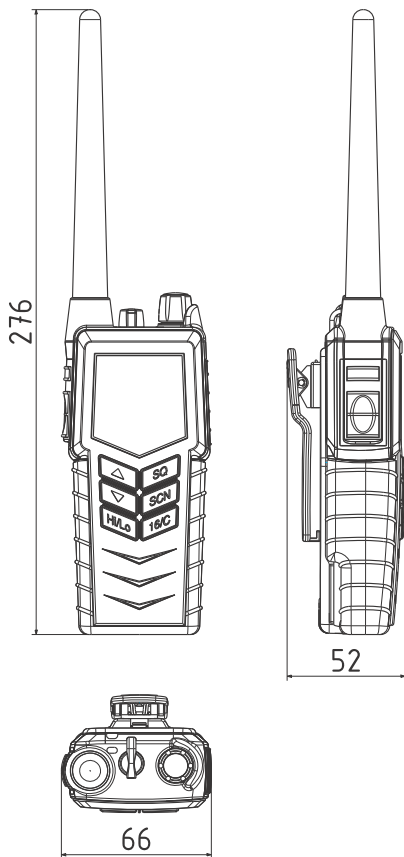

## Dimensional drawing, chargers

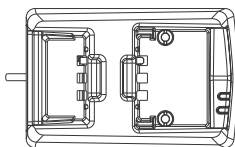
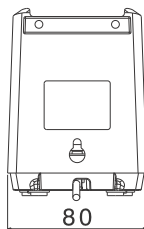
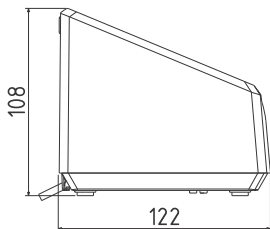

## Mounting Possibilities

Desktop mounting, top view

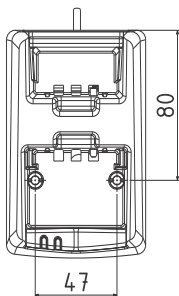

Wall mounting, rear view

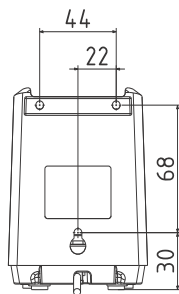





### ***Attention***

#### **Gore-Tex Membrane**

To keep the VHF watertight, it is very important that the Gore-Tex membrane under no circumstances must be damaged/covered or removed.

That is, do not remove the Gore-Tex membrane or place any labels in the area.







98-124294-K

[www.cobham.com/satcom](http://www.cobham.com/satcom)

***COBHAM***